

**UNIVERSE HOME INC
ASSEMBLY INSTRUCTION
CAT HOUSE
ITEM#UH5019**

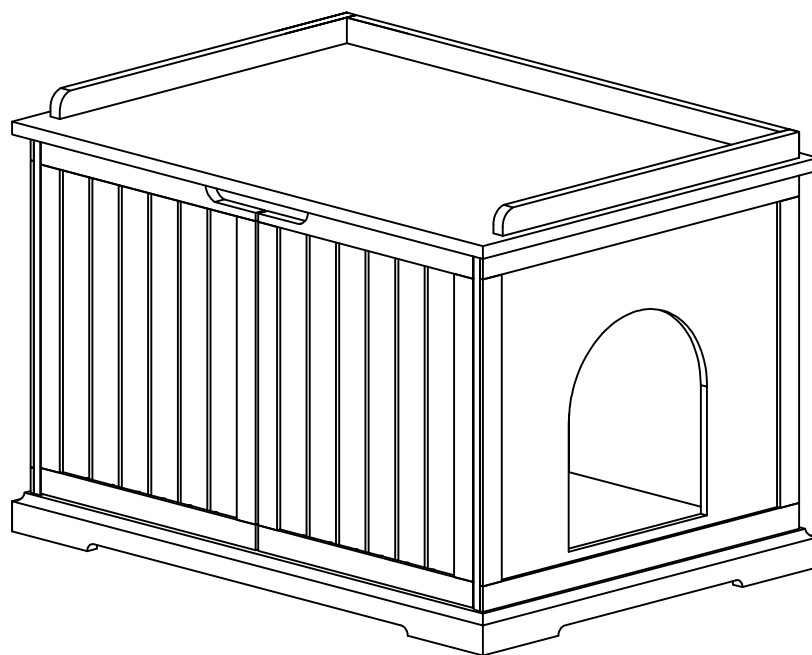

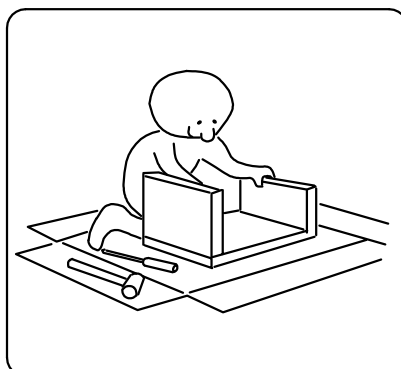
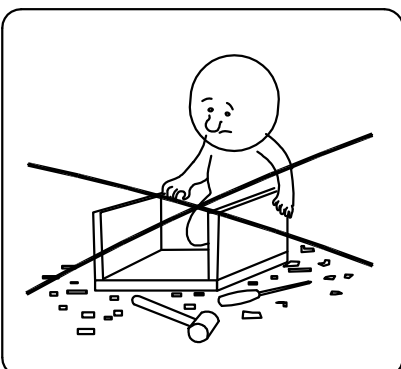
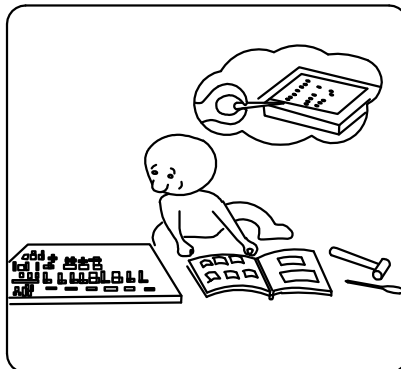
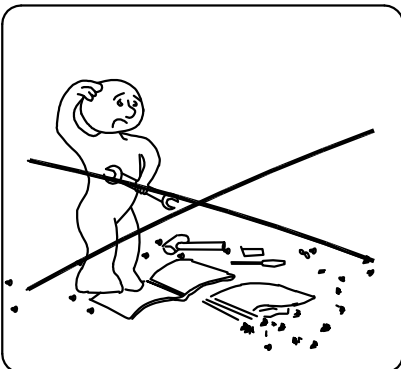
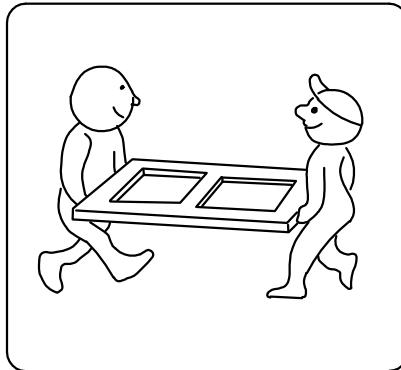
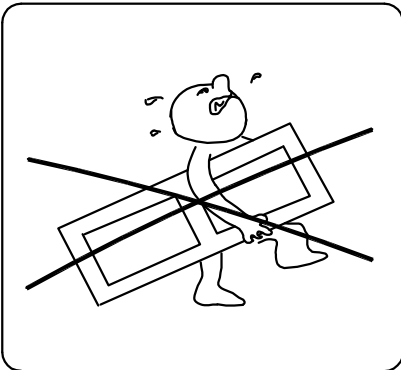
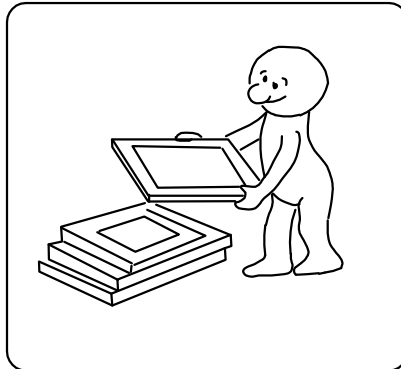
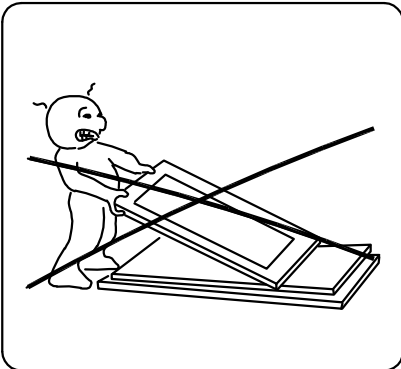
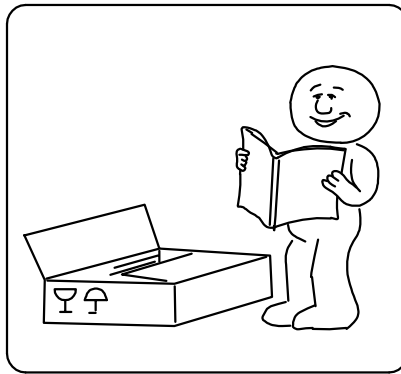
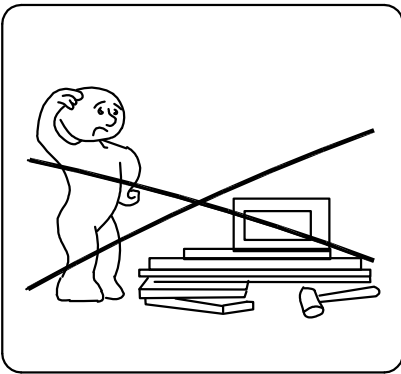

WARNINGS

1. PLEASE READ ALL INSTRUCTIONS CAREFULLY BEFORE STARTING ASSEMBLY.
2. DO NOT LET ANY SHARP OBJECTS TOUCH OR RUB THE SURFACE OF THE PRODUCT.
3. WHEN ASSEMBLING, DO NOT LET CHILDREN PLAY AROUND THE WORKING AREA.
4. PLEASE CONFIRM ALL PARTS ARE CORRECT BEFORE STARTING THE ASSEMBLY PROCESS.
5. DO NOT TIGHTEN ALL BOLTS AND SCREWS COMPLETELY UNTIL THE ENTIRE UNIT HAS BEEN ASSEMBLED AND SET UP.

ADVISE

1. DO NOT SIT OR STAND ON THIS PRODUCT. IT IS INTENDED FOR PETS ONLY.
2. THIS PRODUCT SHOULD BE ASSEMBLED BY AN ADULT.
3. PLEASE PUT THE PRODUCT ON A SMOOTH SURFACE AFTER YOU ASSEMBLED IT.
4. PLACE ALL PARTS ON A CLEAN AND SMOOTH SURFACE SUCH AS A RUG OR CARPET TO AVOID THE PARTS FROM BEING SCRATCHED.
5. THE SCREW OF HINGE ON THE DOOR ALSO CAN BE ADJUSTABLE, TO MAKE IT EVEN THEN TIGHTEN ALL SCREWS.



TOOL NEEDED





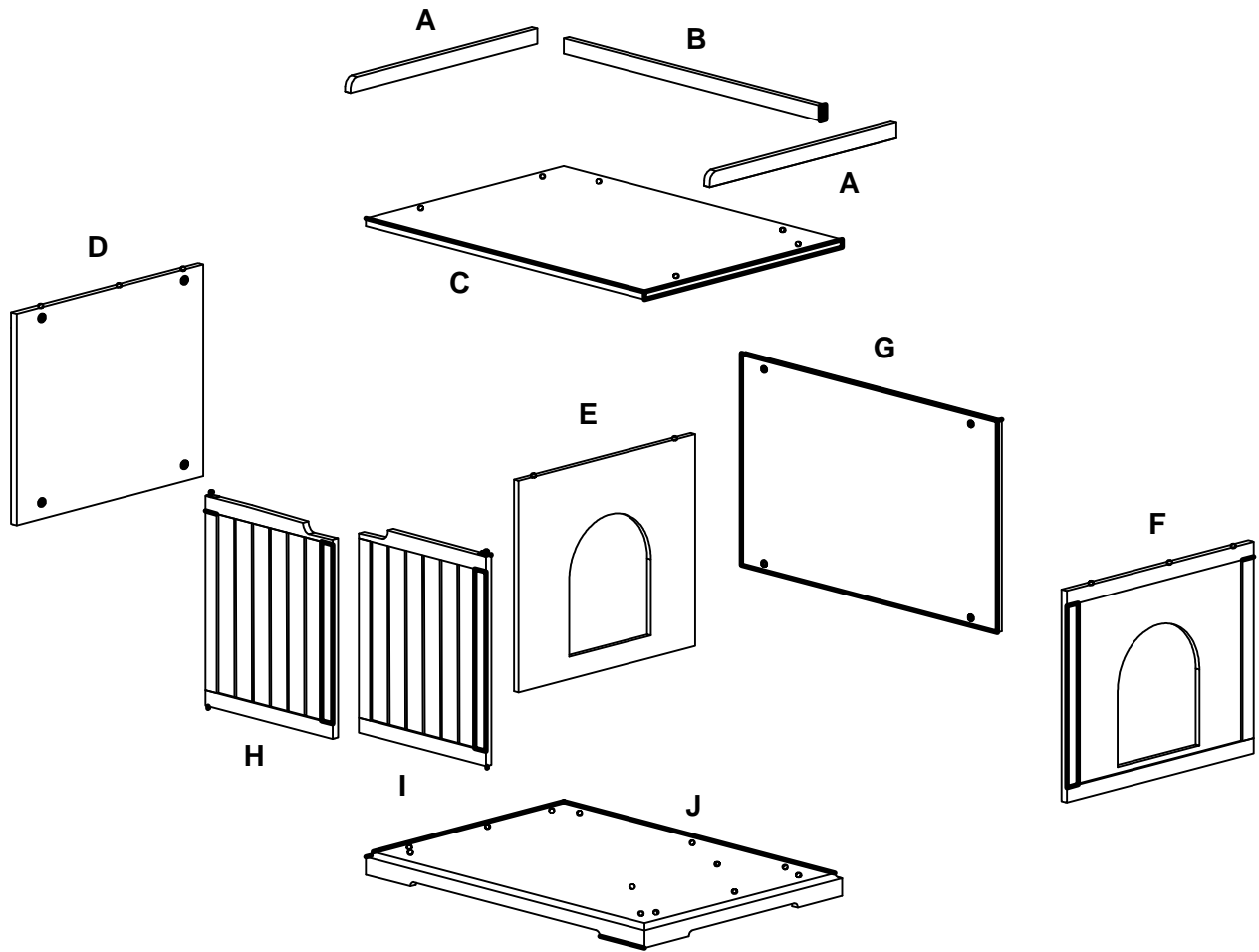

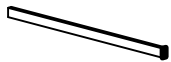
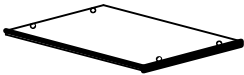
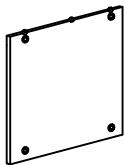
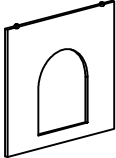
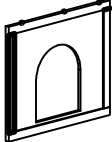
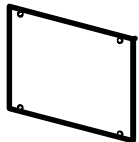
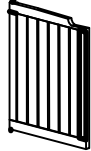
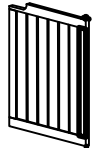

PHILIPS SCREWDRIVER REQUIRED
- NOT INCLUDED

PARTS



 A Upper Side Apron x2	 B Upper Back Apron x1	 C Top Panel x1	 D Left Side Panel x1	 E Divider Panel x1
 F Right Side Panel x1	 G Back Panel x1	 H Left Door Panel x1	 I Right Door Panel x1	 J Bottom Panel x1

HARDWARES

					
1 x 10 pcs	2 x 12 pcs	3 x 12 pcs	4 x 2 pcs	5 x 4 pcs	6 x 6 pcs

ASSEMBLY INSTRUCTIONS

STEP 1:



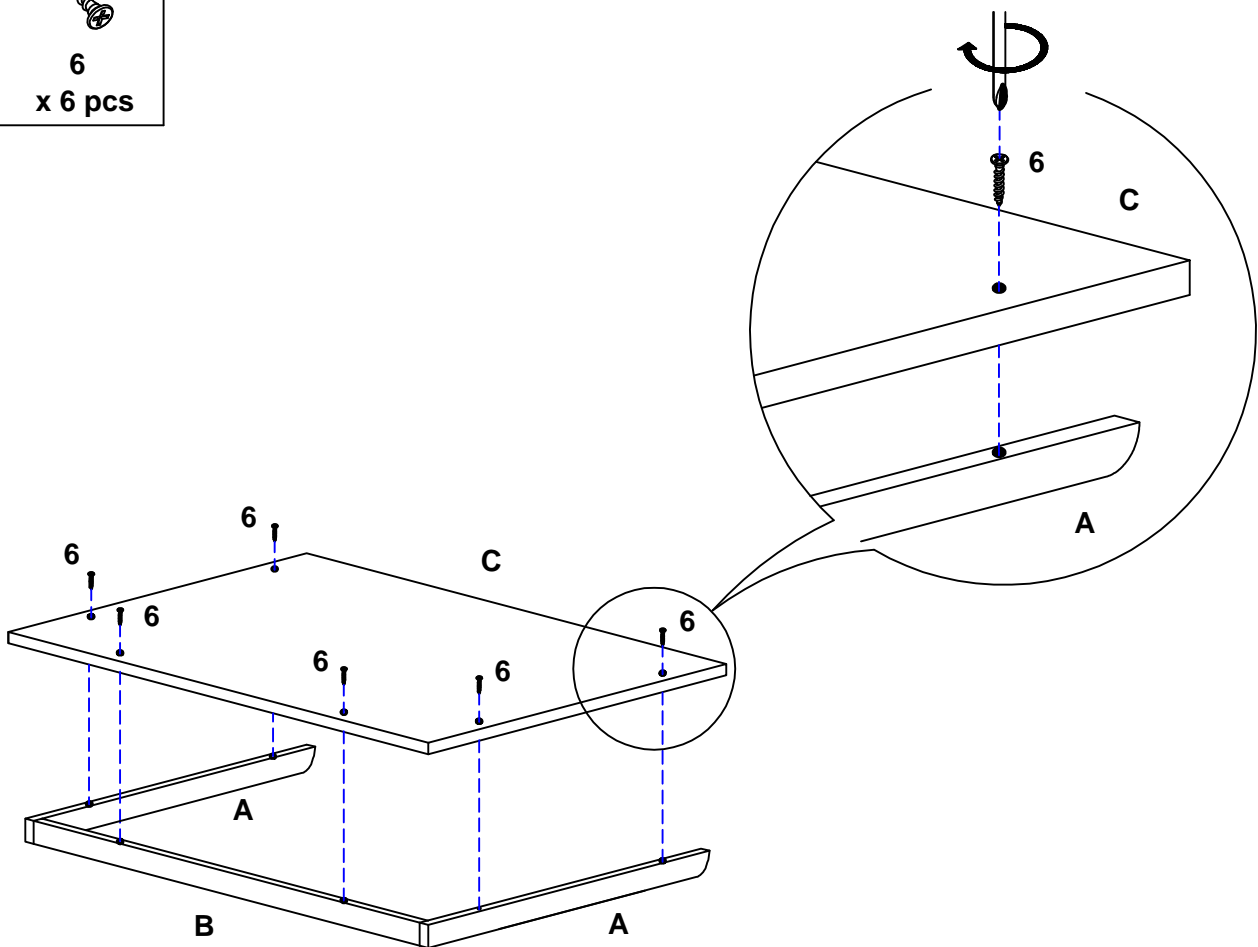
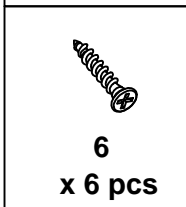

1. Connect upper side apron A and upper back apron B with top panel C.
2. Tighten them with screw #6.



STEP 2:

1. Assemble the magnet #4 to top panel C and tighten them with screw #5.

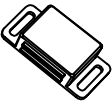
2. Insert the pin #2 and wood dowel #1 into the hole of the bottom panel J & top panel C, and tighten pin#2.

			
1 x 6 pcs	2 x 12 pcs	4 x 2 pcs	5 x 4 pcs

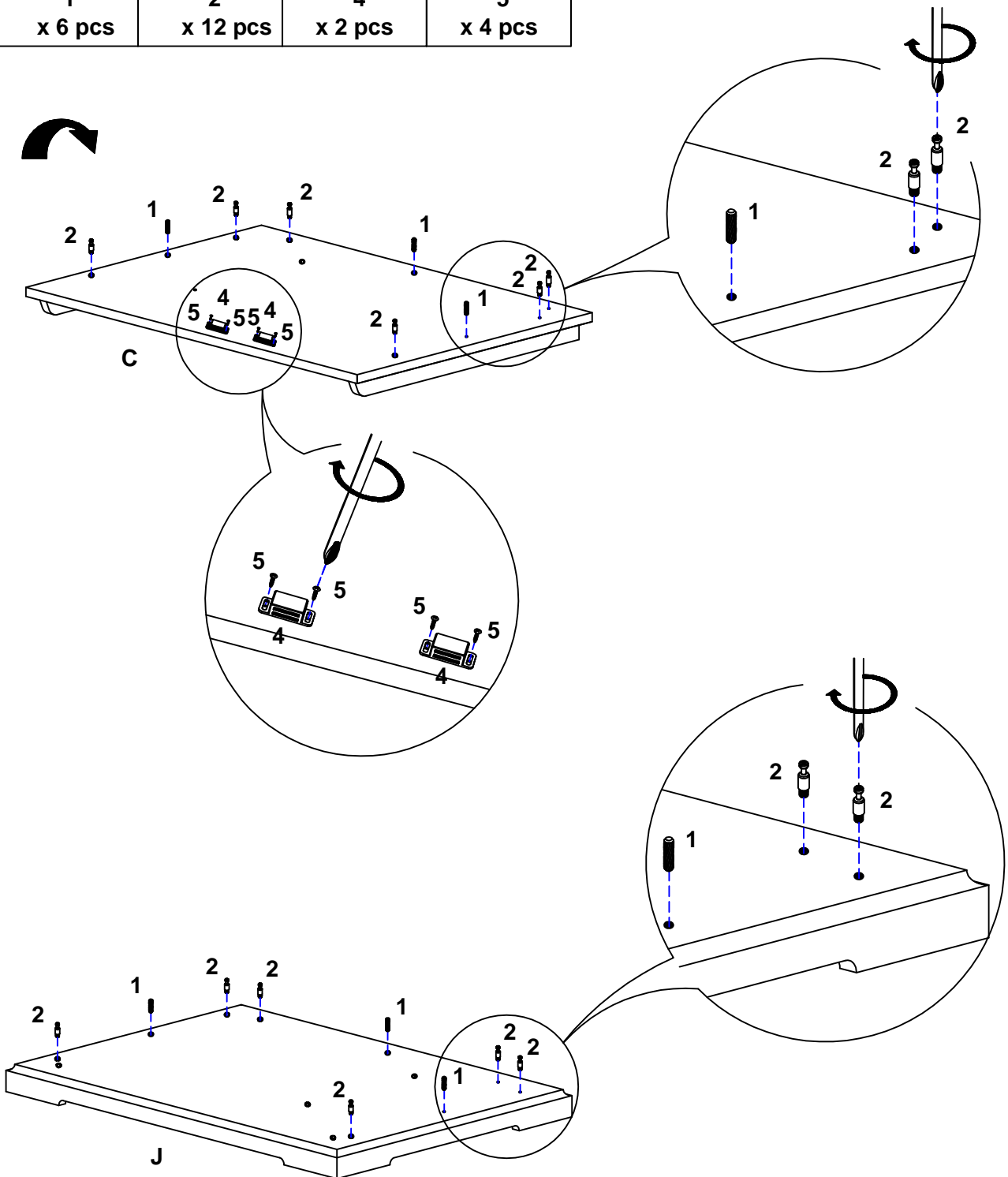

STEP 3:

1. Assemble left side panel D, back panel G and right side panel F to the bottom panel J.
2. Insert the cam lock #3 into the hole of left side panel D, back panel G and right side panel F. Then tighten cam lock #3 to pin #2.



3
x 6 pcs

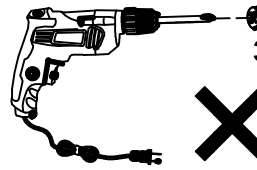

NO!

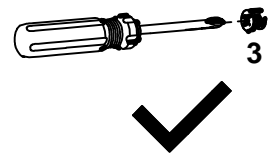

YES!

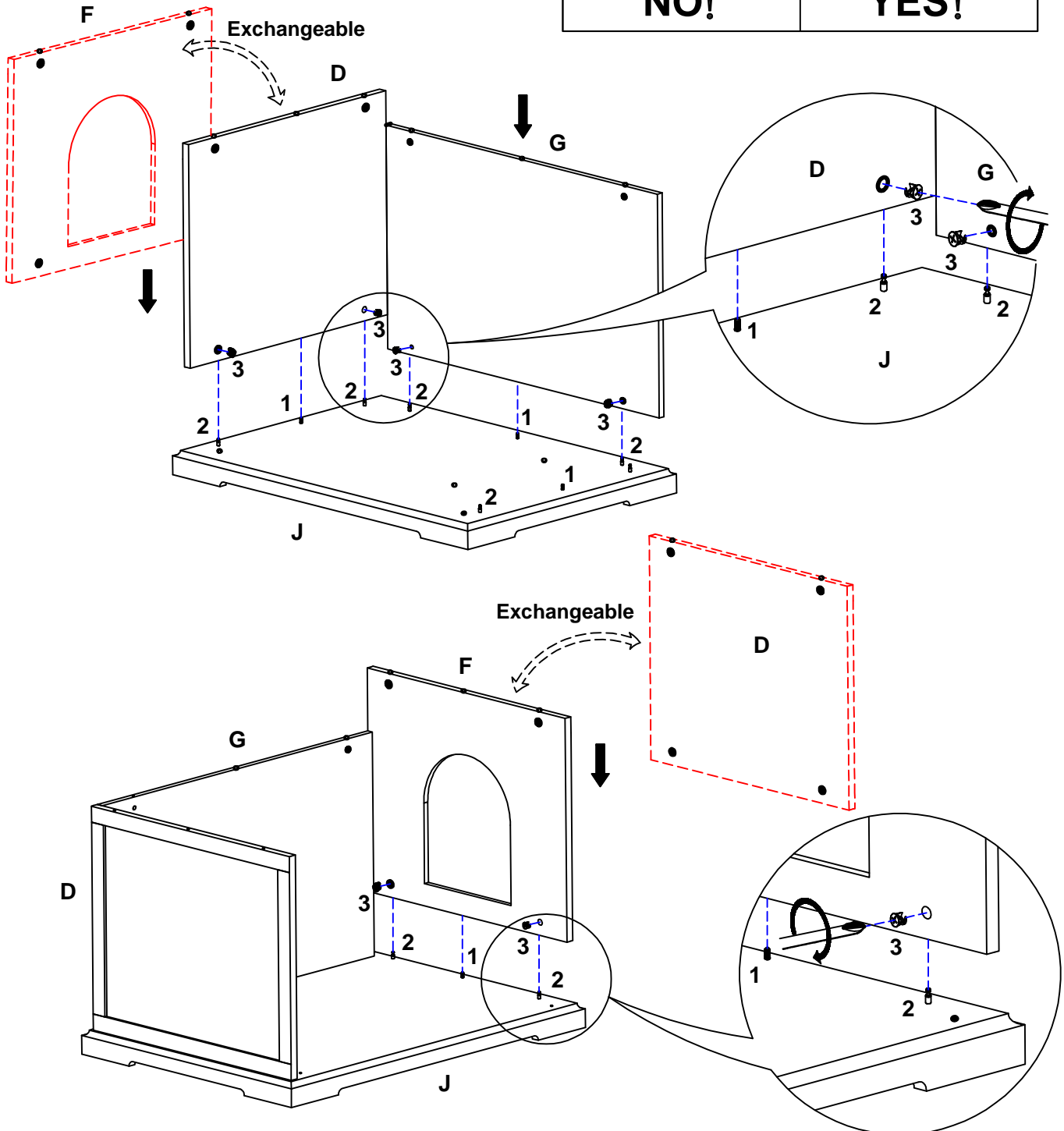

STEP 4:

1. Insert the wooden dowel #1 into the hole of the bottom panel J.
2. Connect the divider panel E to the back panel G.
3. install the left door panel H and right door panel I with bottom panel J.



1
x 2 pcs

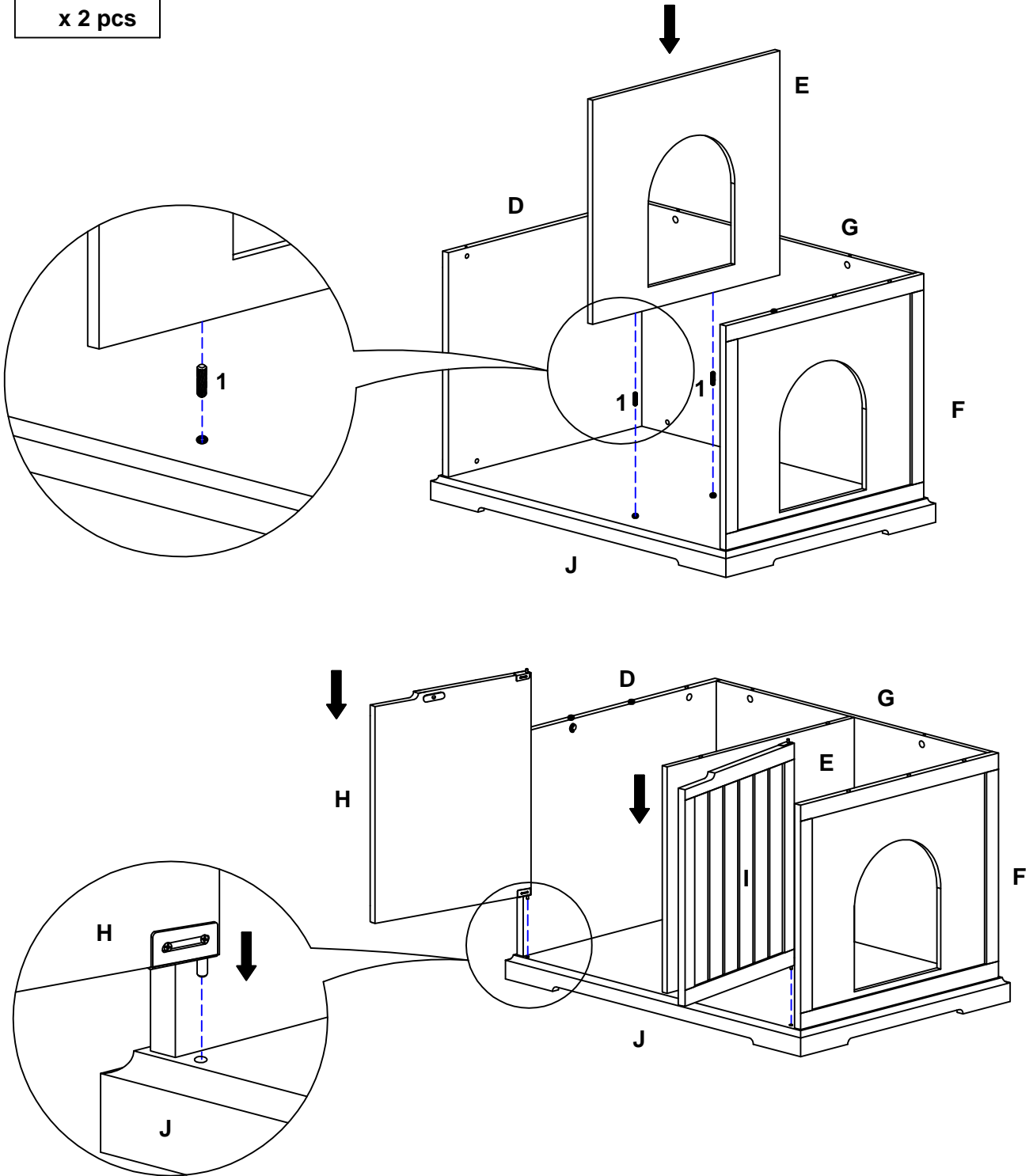

STEP 5:

1. Insert wooden dowel #1 on the hole of the divider panel E and put the top panel C onto the product.

2. Open the two doors and insert the cam lock #3 on the hole of left side panel D, right side panel F and back panel G. Then tighten cam lock #3 to pin #2.

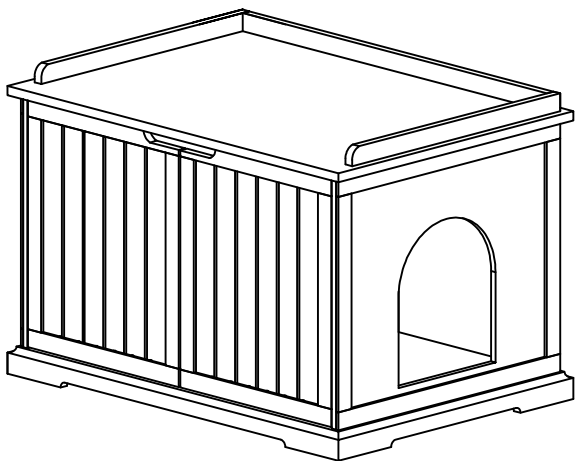
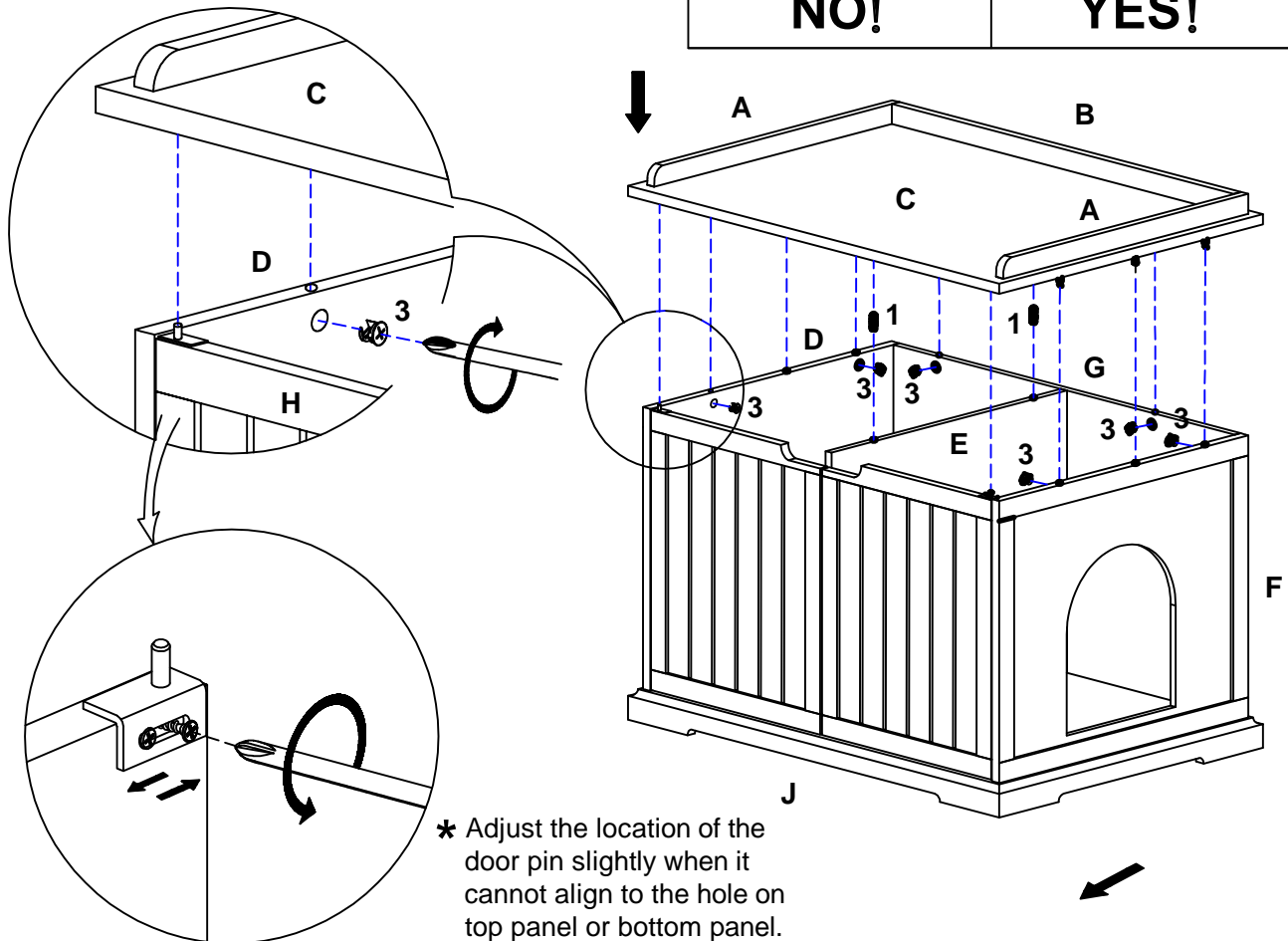
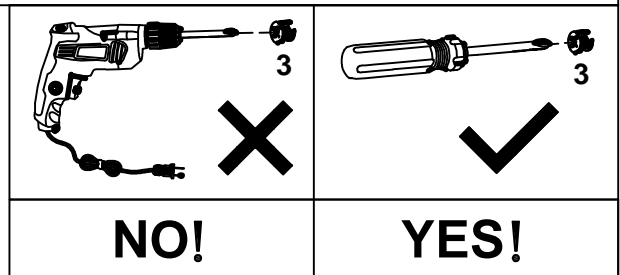
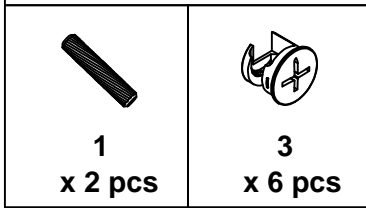

or

